

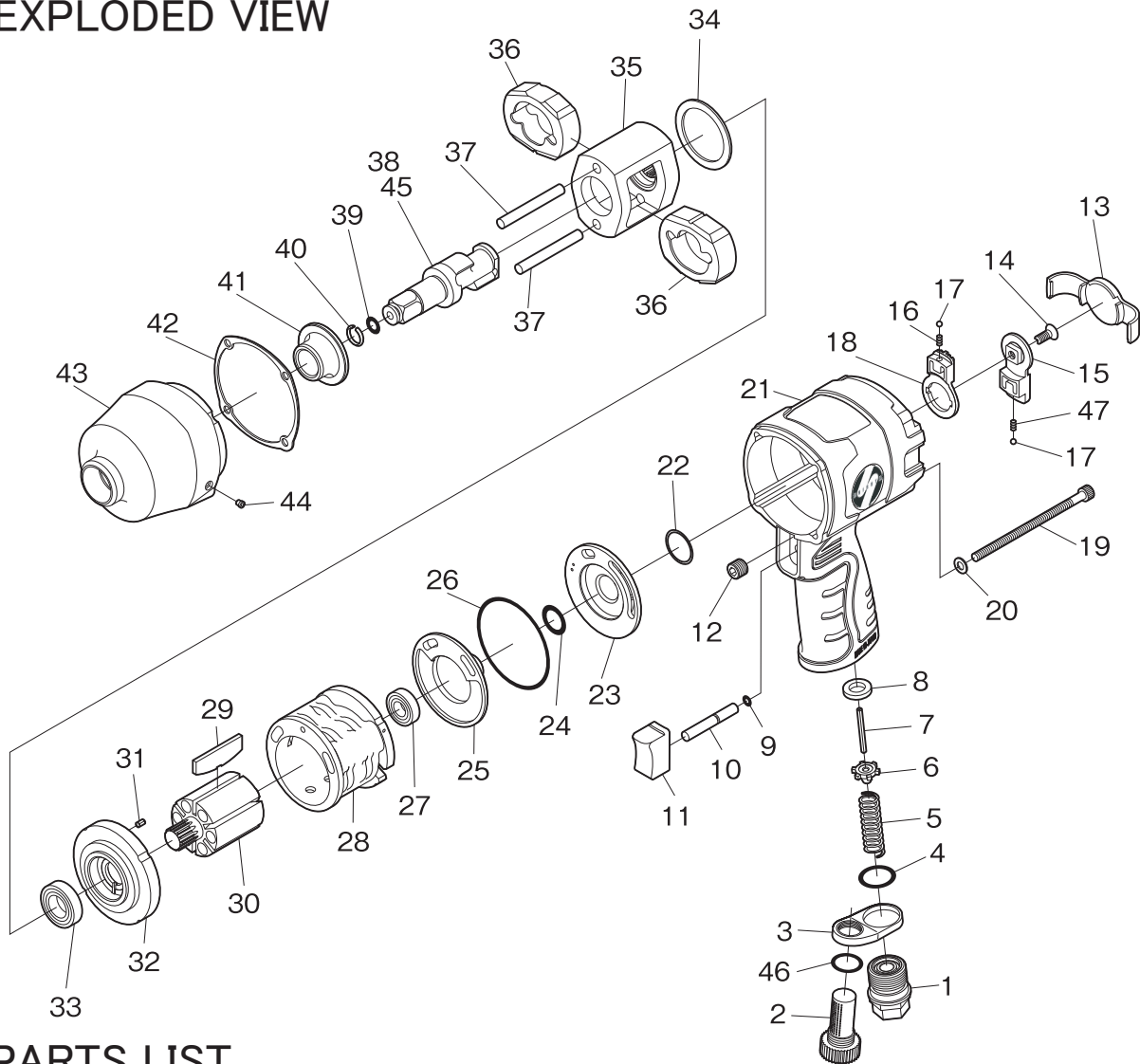

TSW-418P

1/2" Sq. Dr. Impact Wrench

EXPLODED VIEW



PARTS LIST

Ref. No.	Description	Q'ty	Part Code	Ref. No.	Description	Q'ty	Part Code
1	Inlet Bushing	1	418-001	25	Reverse Valve	1	418-025
2	Muffler	1	418-002	26	O-Ring	1	418-026
3	Muffler Retainer	1	418-003	27	Ball Bearing	1	418-027
4	O-Ring	1	418-004	28	Cylinder	1	418-028
5	Valve Spring	1	418-005	29	Rotor Blade	6	418-029
6	Valve	1	418-006	30	Rotor	1	418-030
7	Roll Pin(3φ-32mm)	1	418-007	31	Roll Pin(3φ-5mm)	1	418-031
8	Valve Seat	1	418-008	32	Front Plate	1	418-032
9	O-Ring	1	418-009	33	Ball Bearing	1	418-033
10	Valve Shaft	1	418-010	34	Spacer	1	418-034
11	Trigger	1	418-011	35	Hammer Cage	1	418-035
12	Set Screw	1	418-012	36	Hammer Dog	2	418-036
13	Rear Cover	1	418-013	37	Hammer Pin	2	418-037
14	Screw	1	418-014	38	1/2" Sq. Anvil	1	418-038
15	Reverse Lever	1	418-015	39	O-Ring	1	418-039
16	Spring	1	418-016	40	Socket Retainer Ring	1	418-040
17	Steel Ball	2	418-017	41	Anvil Bushing	1	418-041
18	Regulator Lever	1	418-018	42	Gasket	1	418-042
19	Cap Screw	4	418-019	43	Clutch Housing incl. Anvil Bushing	1	418-043
20	Washer	4	418-020	44	Grease Plug	1	418-044
21	Motor Housing	1	418-021				
22	O-Ring	1	418-022	46	O-Ring	1	418-046
23	Regulator Valve	1	418-023	47	Spring	1	418-047
24	O-Ring	1	418-024				